

Copyright © 2018 by The Gortor Company BV - Schagen, the Netherlands
 All rights reserved. This drawing is the property of publisher and incorporates specifications and designs in which publisher has proprietary rights.
 No part may be reproduced, stored in a database or retrieval system or published in any form or any way without prior written permission from the publisher.

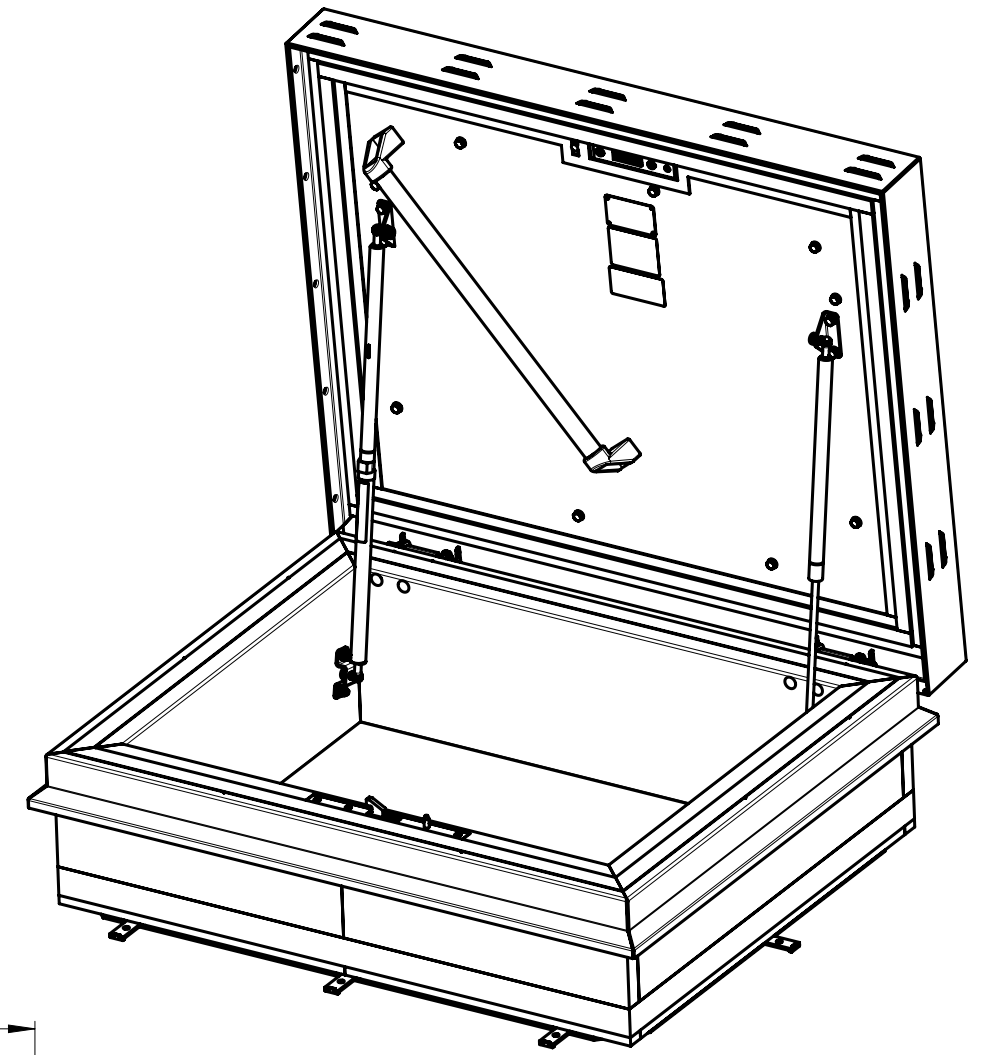
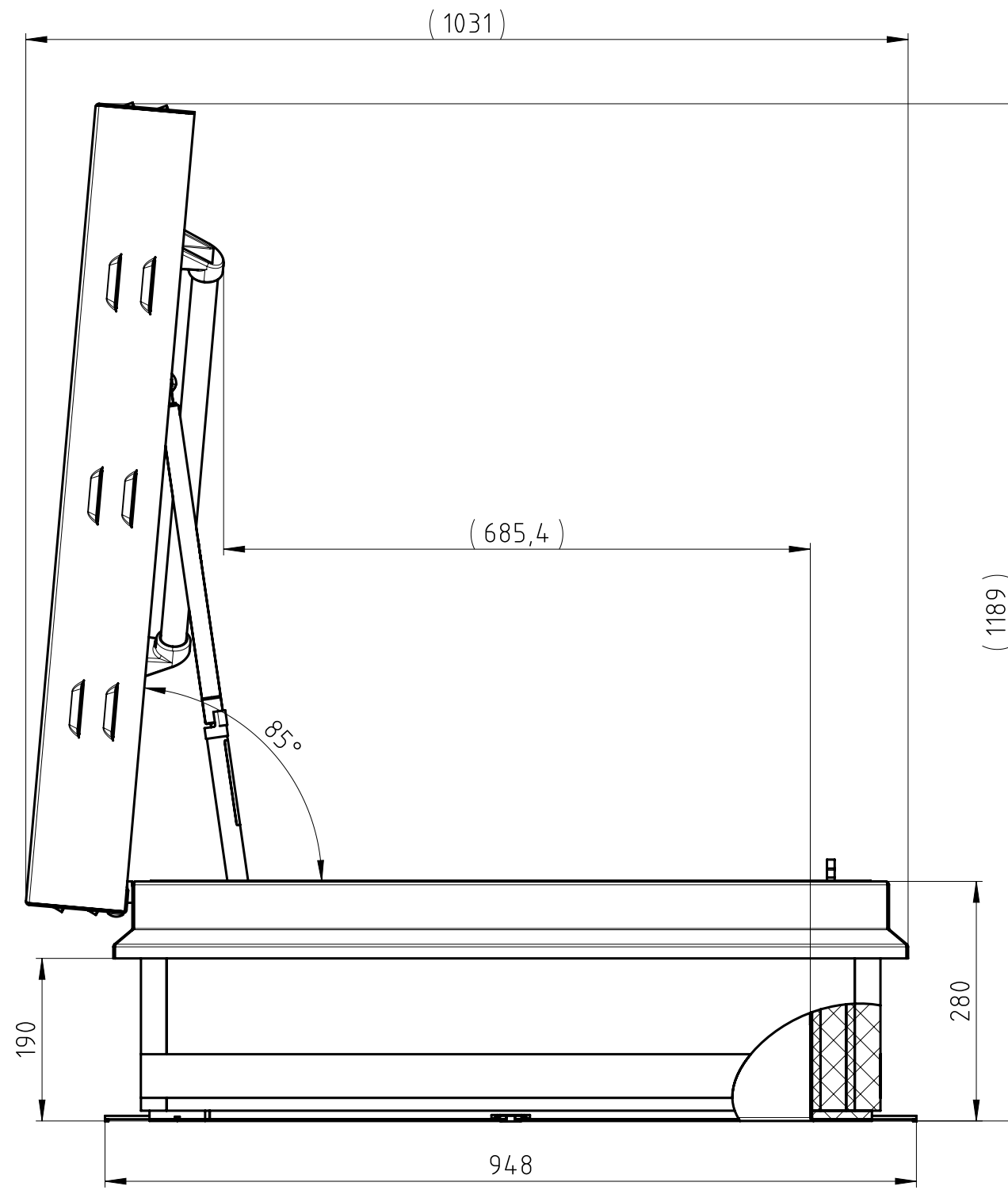
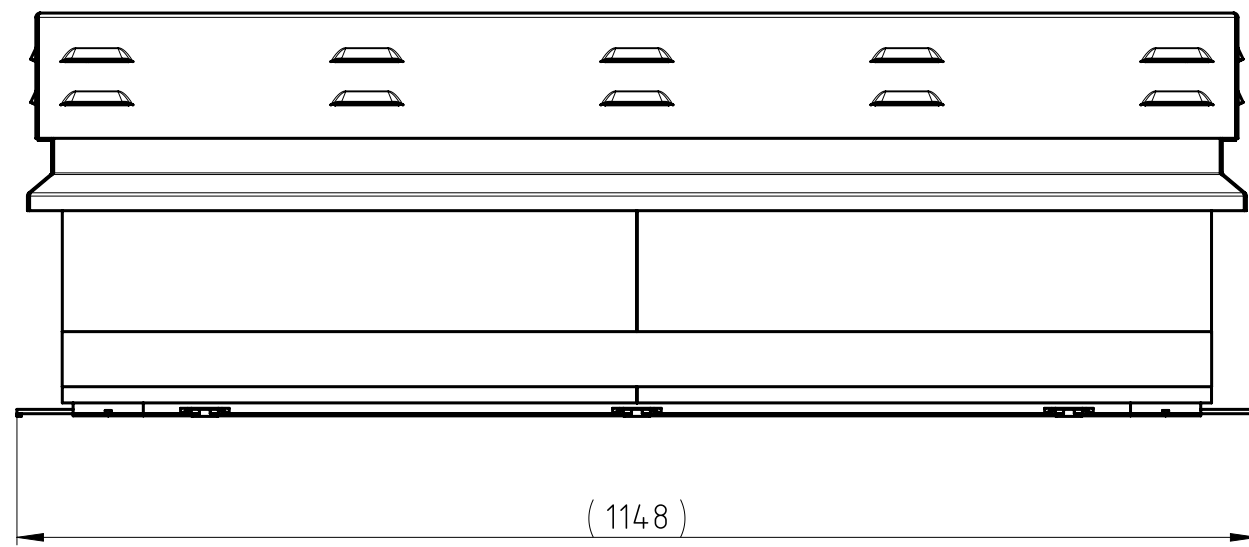
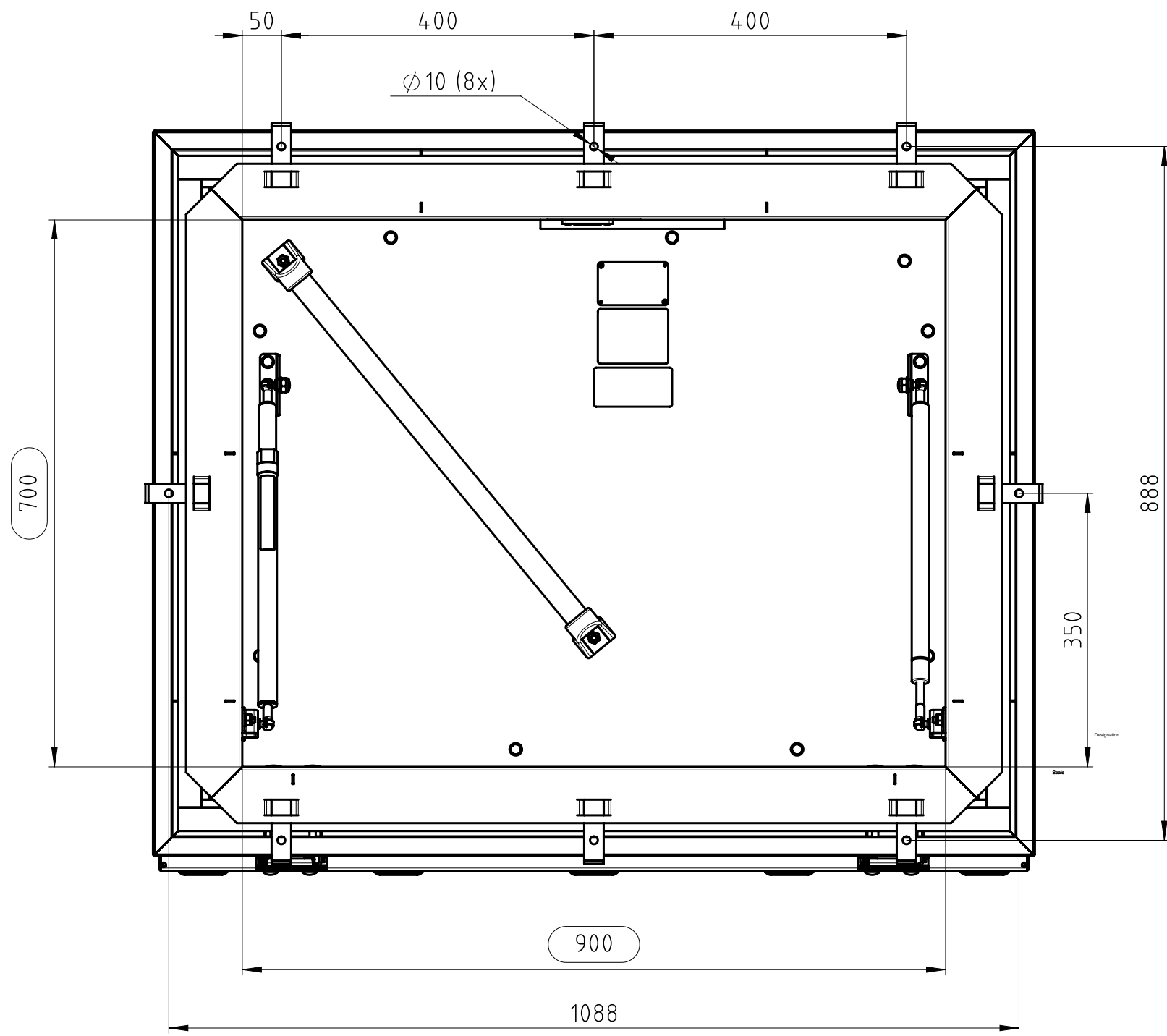

				The Gortor Company BV PO Box 265 NL-1740 AG SCHAGEN www.gortorgroup.com E-mail: sales@gortorgroup.com Tel: +31 224 21 98 60 Fax: +31 224 21 98 61	
		Designation Roof Hatch RHTEI			
Projection view 	Scale 1:7	Drawing number RHTEI-0700-0900	Rev. 1/1		
			A2		