

Copyright © 2018 by The Gorter Company BV - Schagen, the Netherlands
 All rights reserved. This drawing is the property of publisher and incorporates specifications and designs in which publisher has proprietary rights.
 No part may be reproduced, stored in a database or retrieval system or published in any form or any way without prior written permission from the publisher.

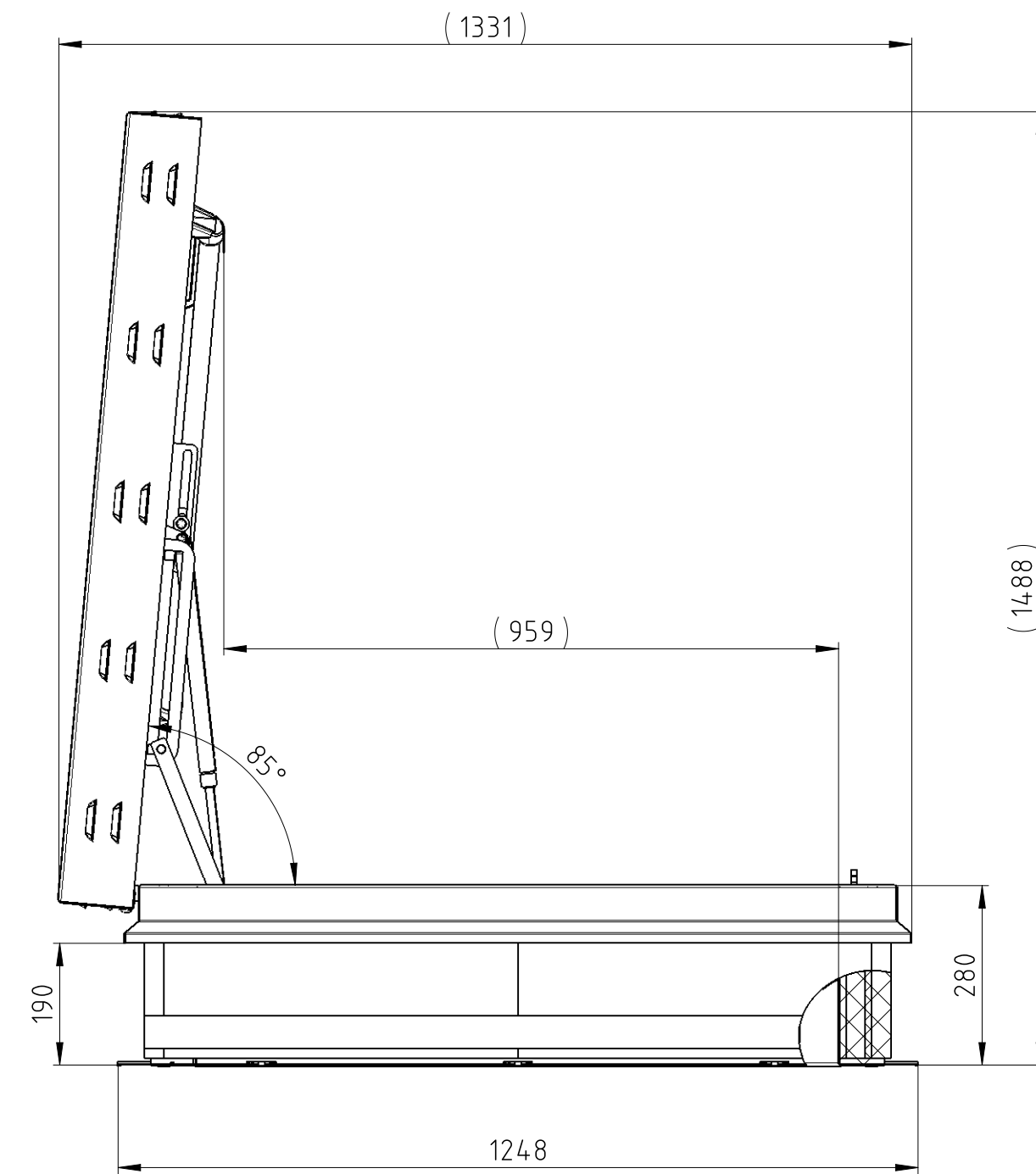
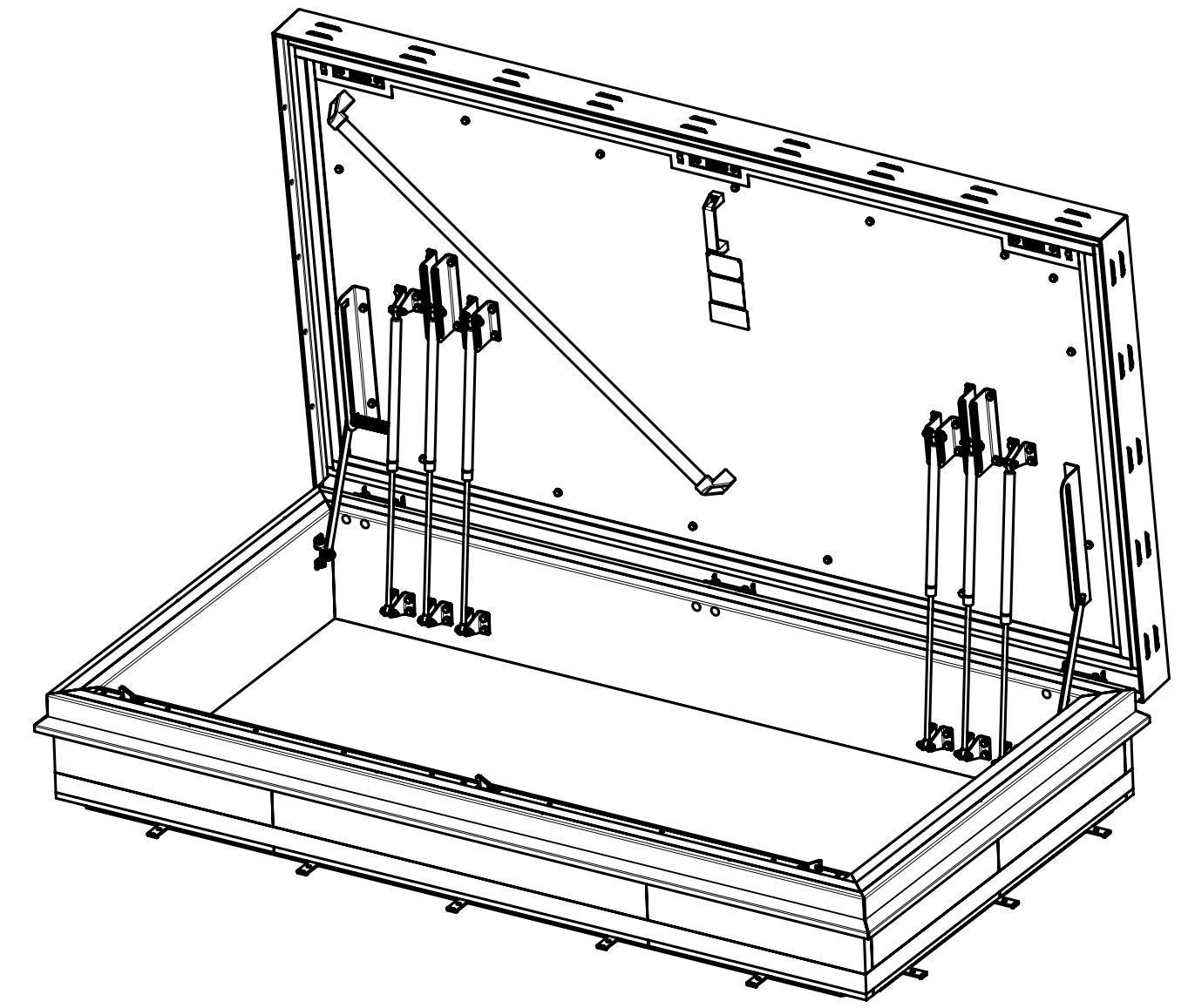
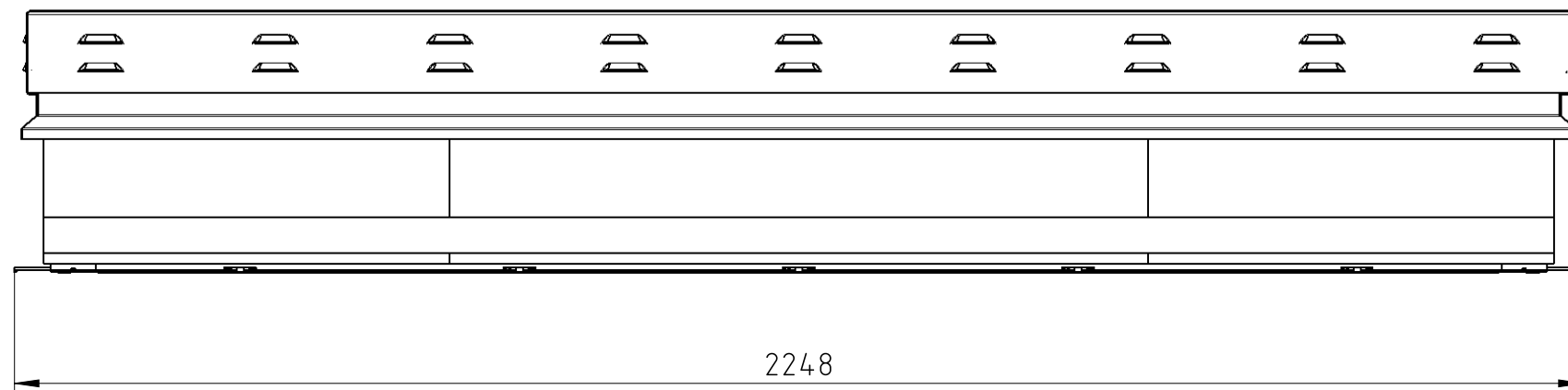
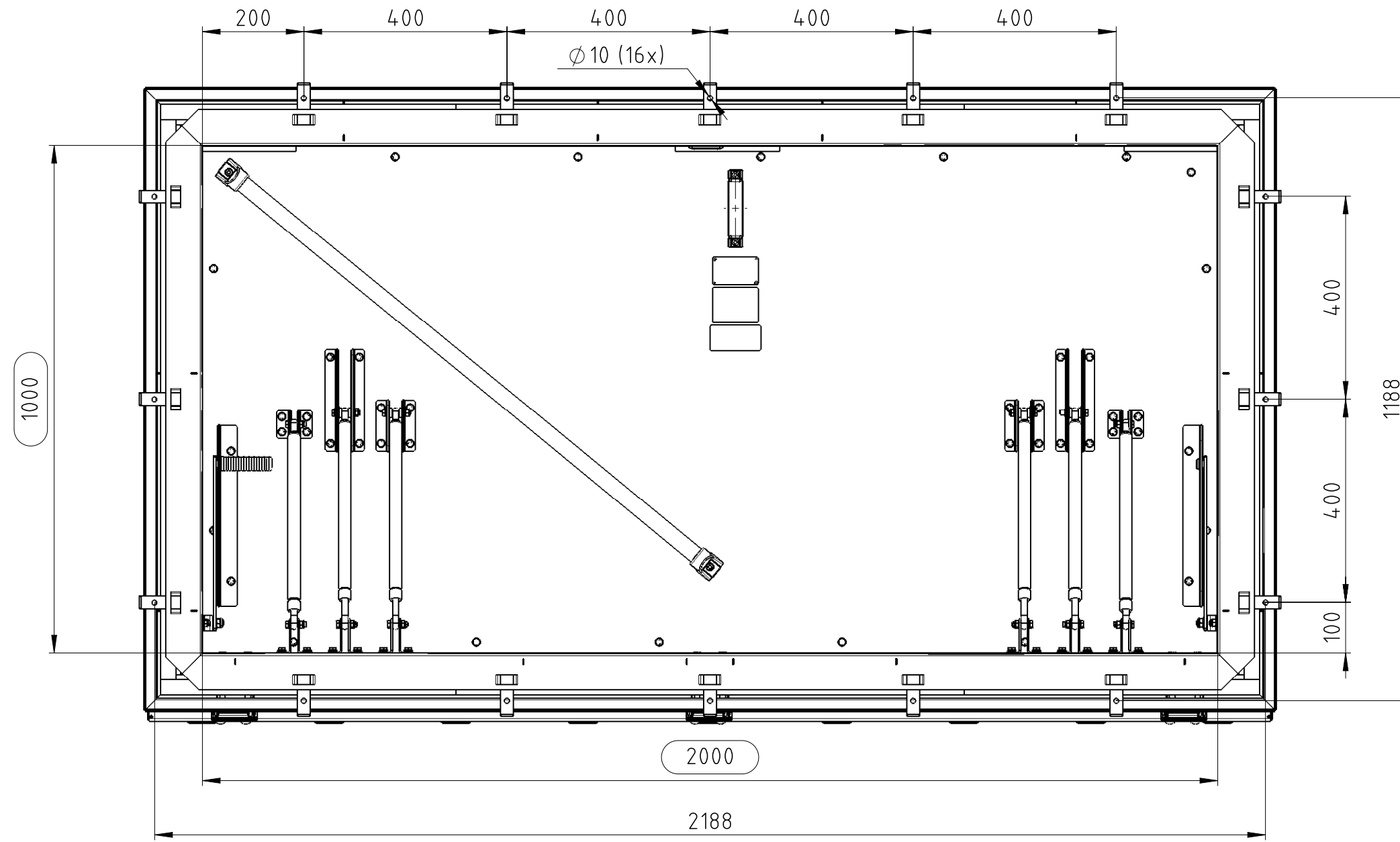

				The Gorter Company BV PO Box 265 NL-1740 AG SCHAGEN www.gortergroup.com E-mail: sales@gortergroup.com Tel: +31 224 21 98 60 Fax: +31 224 21 98 61	
		Designation Roof Hatch RHTEI			
Projection view 		Scale 1:10	Drawing number RHTEI-1000-2000	Rev. 1/1	A2